



DIMENSIONS

Trash Vortex Pumps S3000-TS4P

STANCOR

Dwg:

DS-A24-016

Rev:

Date: 06/16

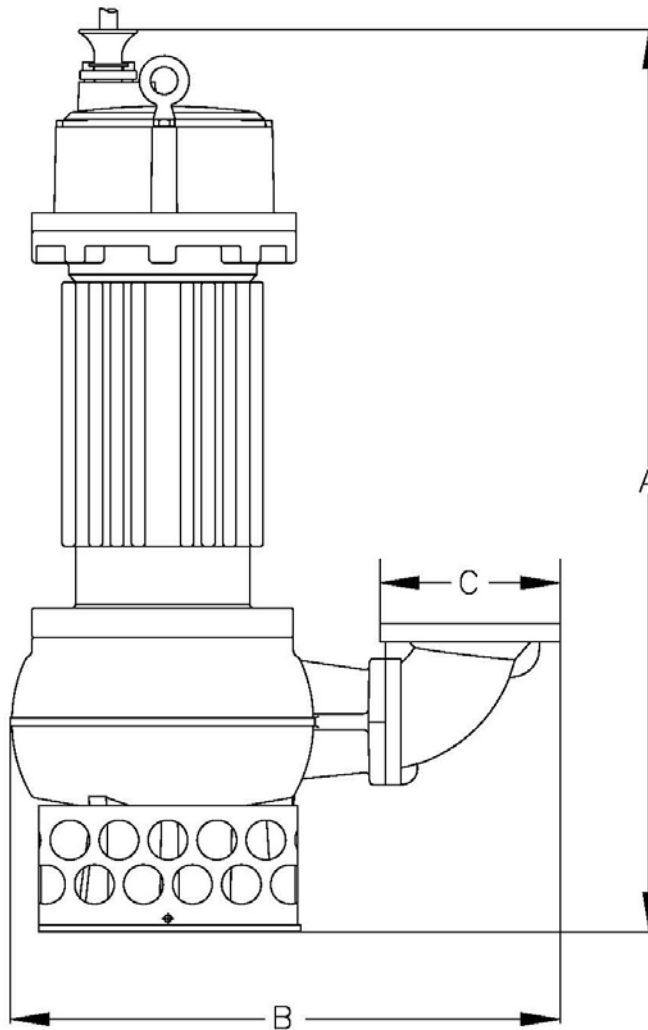

Dimensions	A	B	C
Trash Vortex	45 1/4"	30"	4" ANSI Class 125 FF

Specifications subject to change without notice

Stancor, Inc. 515 Fan Hill Road, Monroe, CT 06468

Tel: 203-268-7513

Fax : 203-268-7958

www.stancorpumps.com